

# JK-2400

## 速马高速双伺服单片钉箱机

RMB 145,000



无品质 不彩盒



## JK-2400-A 高速双伺服单片钉箱机简介



速马 JK-2400 双伺服单片钉箱机是一款纸箱厂必备的经典设备，由伺服控制走纸系统和钉头驱动。设备采用触摸屏人机对话界面，使用方便，工作稳定。配有自动计数功能和定额分离送出功能，方便后段结束作业。

**我们更注重设备的效率和稳定性**

## JK-2400-A 高速双伺服单片钉箱机简介

### 技术参数

支持无盖箱、有盖箱

一分钟快速换单

钉距:20-140mm 伺服系统触摸屏操控, 钉距无级调节 (在触摸屏上设定)

机械速度: 450钉/分钟

钉数: 1~199

钉线规格: 2.0mm×(0.65mm~0.75mm) 17#-18#

钉种: 单钉、双钉

最小用纸: 300×606mm

最大用纸: 1500×2400mm

总马力: 6HP

机械重量: 2000kg















送纸台推叠高度: 900mm

适用纸板: 3层、5层 (3mm-8mm)

支持单钉、双钉、加强钉一次性完成

成品自动计数并可设定分离送出

无钉线自动报警、故障报警 (触摸屏显示故障点)

单钉	双钉	加强钉
		
		
		
		
		

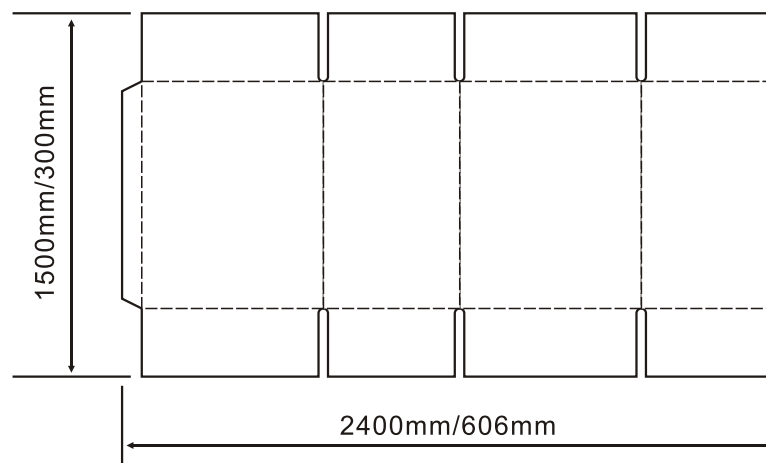

## JK-2400-A 高速双伺服单片钉箱机简介

### 机器尺寸

